

HONDA CB750 HORNET '23-

M O U N T I N G I N S T R U C T I O N S



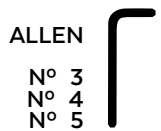
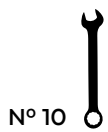

VIDEO

REF 21481

ENGINE SPOILER

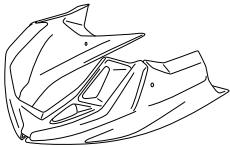
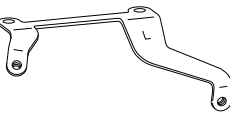
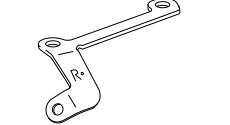
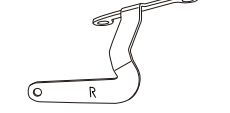

COMPATIBLE WITH ARROW EXHAUST

ID	PIEZA/PART	DESCRIPCIÓN	DESCRIPTION	QTY	REF
1		Quilla	Engine spoiler	1	21481J/N/CM3
2		Soporte izquierdo (L)	Left support (L)	1	SOP3P13--L21481
3		Soporte delantero derecho (Rº)	Right front support (Rº)	1	SOP3P13-FR21481
4		Soporte trasero derecho (R)	Right rear support (R)	1	SOP3P13-RR21481
5		Silentblock Ø12xØ6x9	Ø12xØ6x9 silentblock	4	AROPASACABLES-1
6		Casquillo con valona Ø12xØ6,8x7,3	Ø12xØ6,8x7,3 bush with flange	4	CASQUI-1A---750
7		Tornillo Allen M5x16 Ø11 ISO 7380	M5x16 Ø11 ISO 7380 Allen screw	4	TORNI-I7380-493
8		Tapón tornillo M5 ISO 7380	M5 ISO 7380 screw cap	4	TAPON-----85

* Algunos componentes se suministran montados.
Some components are supplied assembled.

HONDA CB750 HORNET '23-

INSTRUCCIONES DE MONTAJE - MOUNTING INSTRUCTIONS - MONTAGEANLEITUNG

1A

DISASSEMBLY
DESMONTAJE

WITH ORIGINAL EXHAUST

RIGHT SIDE

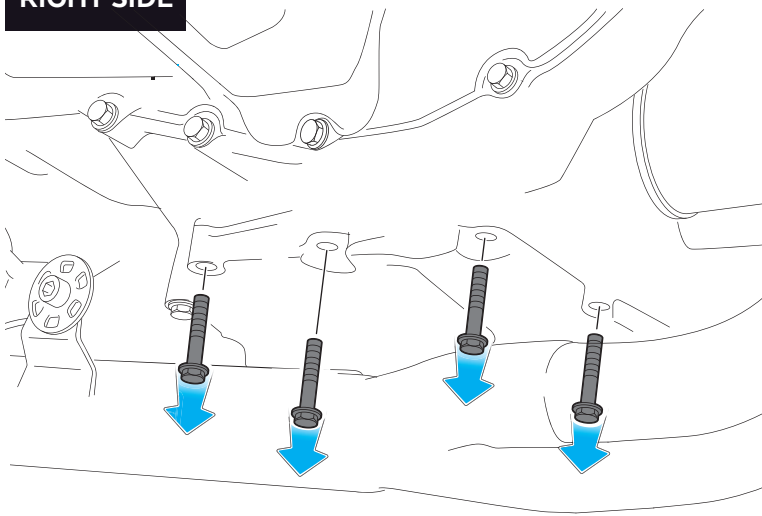

1B

DISASSEMBLY
DESMONTAJE

WITH ARROW EXHAUST

RIGHT SIDE

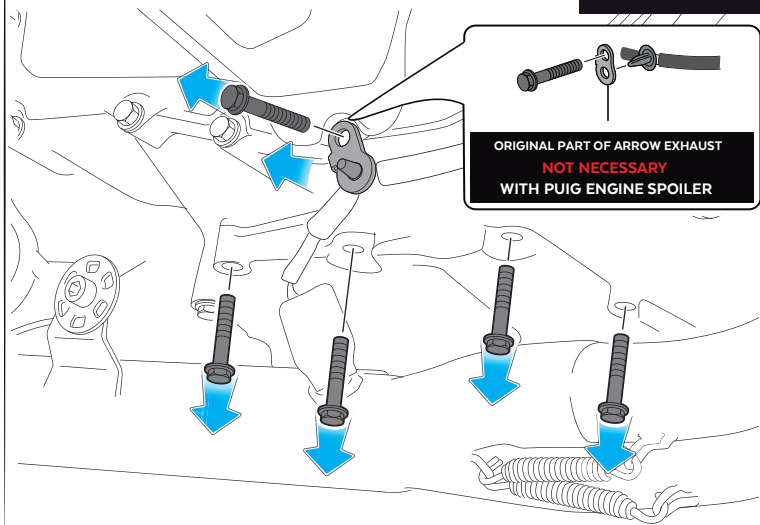

2

ASSEMBLY
MONTAJE

RIGHT SIDE

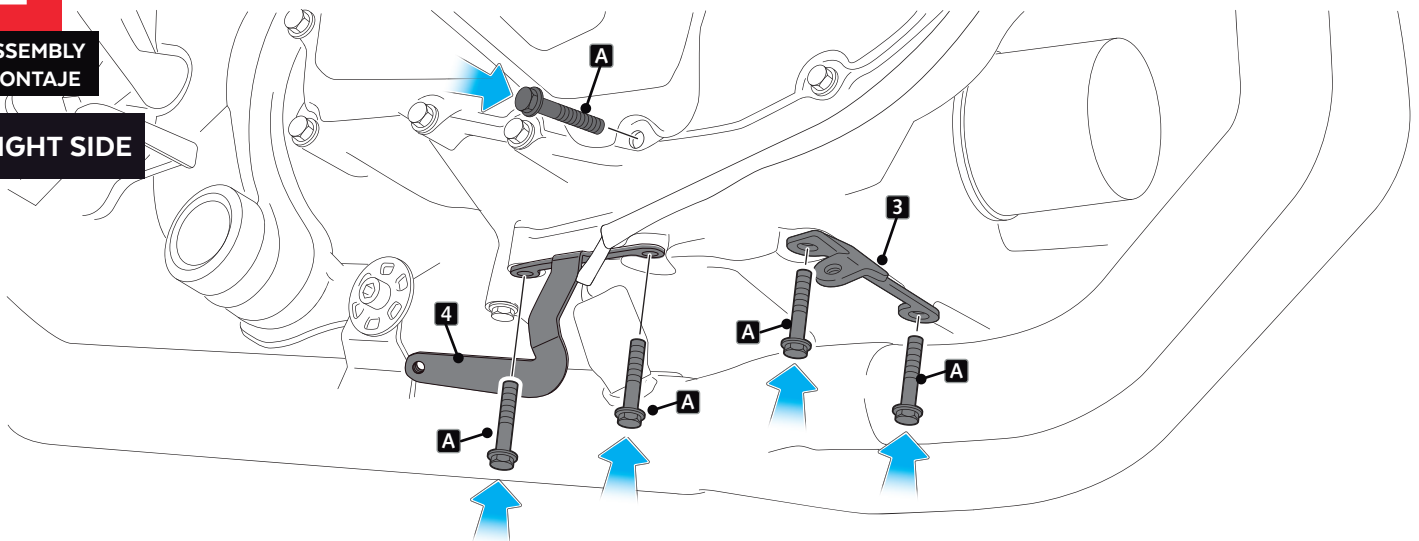

A  Par Apriete - 10 Nm
Tightening Torque - 10 Nm

A PIEZA ORIGINAL
ORIGINAL PART

HONDA CB750 HORNET '23-

INSTRUCCIONES DE MONTAJE - MOUNTING INSTRUCTIONS - MONTAGEANLEITUNG

3

DISASSEMBLY
DESMONTAJE

LEFT SIDE

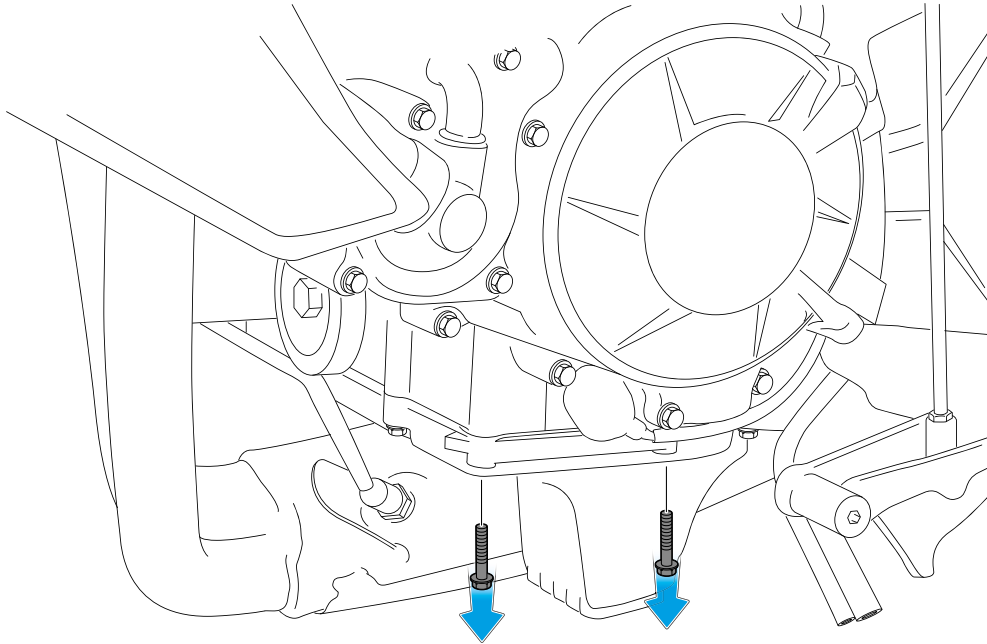

4

ASSEMBLY
MONTAJE

LEFT SIDE

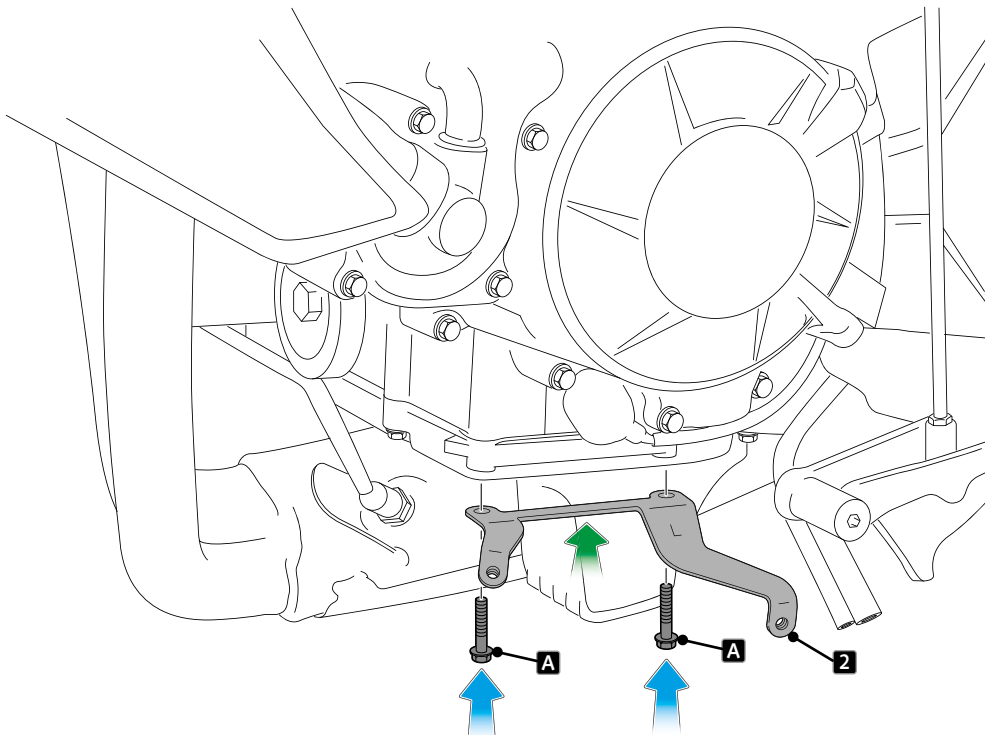

A  Par Apriete - 10 Nm
Tightening Torque - 10 Nm

A PIEZA ORIGINAL
ORIGINAL PART

HONDA CB750 HORNET '23-

INSTRUCCIONES DE MONTAJE - MOUNTING INSTRUCTIONS - MONTAGEANLEITUNG

5

ASSEMBLY
MONTAJE

RIGHT SIDE

WITH ARROW EXHAUST
IT'S NECESSARY TO POSITION
THE OXYGEN SENSOR CABLE

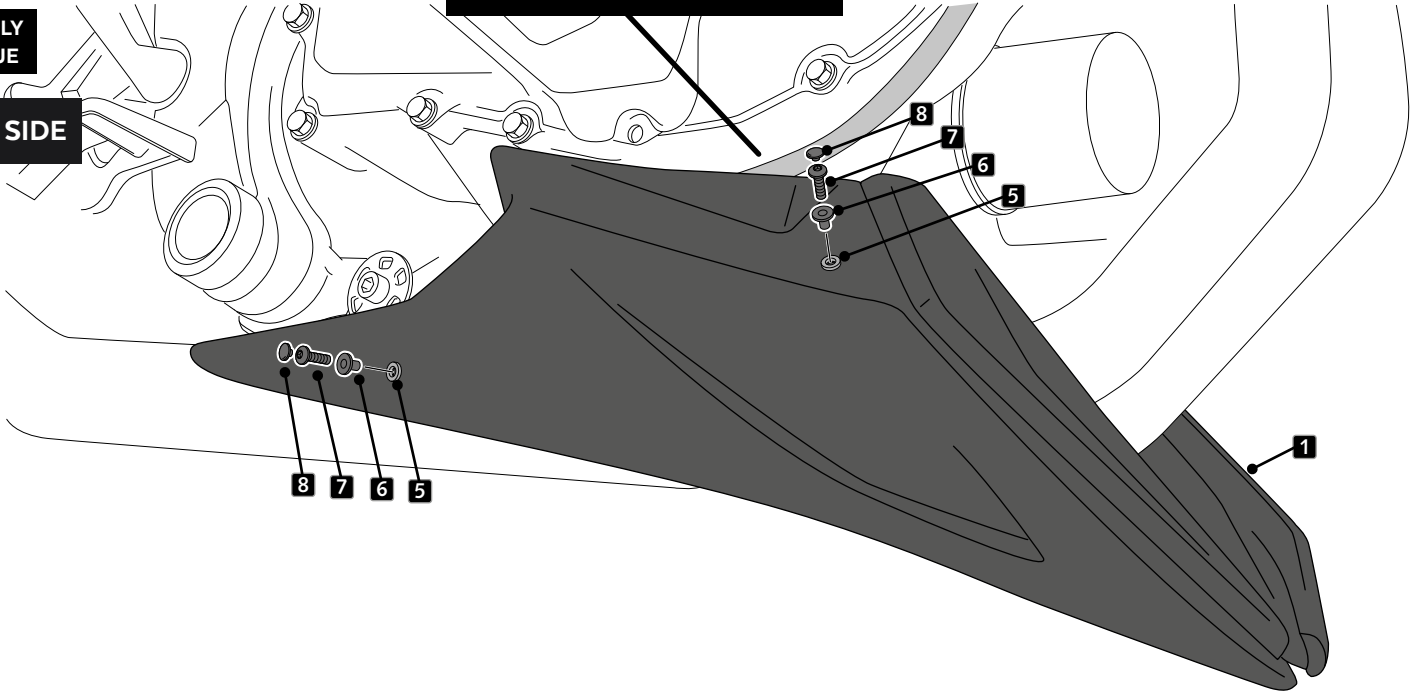

6

ASSEMBLY
MONTAJE

LEFT SIDE

