

MOTOPLASTIC, S.A.

Molí de la sal, 1 - 08403 Granollers (Barcelona) SPAIN

Tel. 34 93 849 06 33 - Fax 34 93 849 09 88

info@puig.tv - info@puigusa.com

www.puig.tv - www.puigusa.com

INSTRUCCIONES DE MONTAJE - MOUNTING INSTRUCTIONS - MONTAGEANLEITUNG

QUILLA ADAPTABLE A – ENGINE SPOILER FOR – BUGSPOILER FÜR

MV AGUSTA BRUTALE 675/800

Ref.: 6046J
(color negro/black colour)

Ref.: 6046C
(color carbono/carbón look)

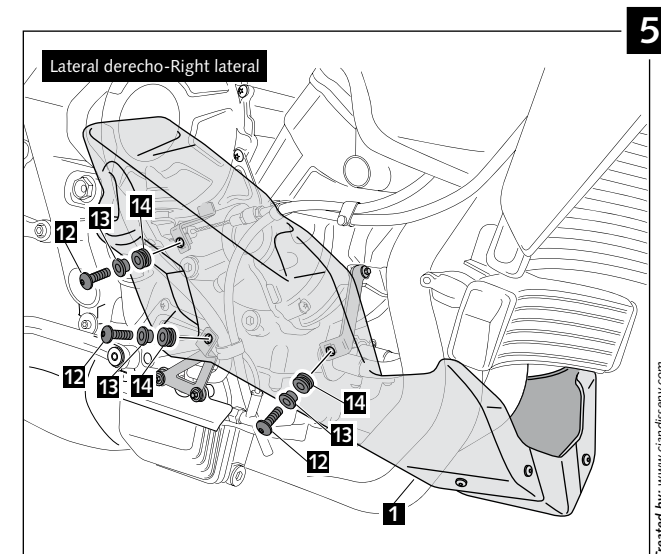
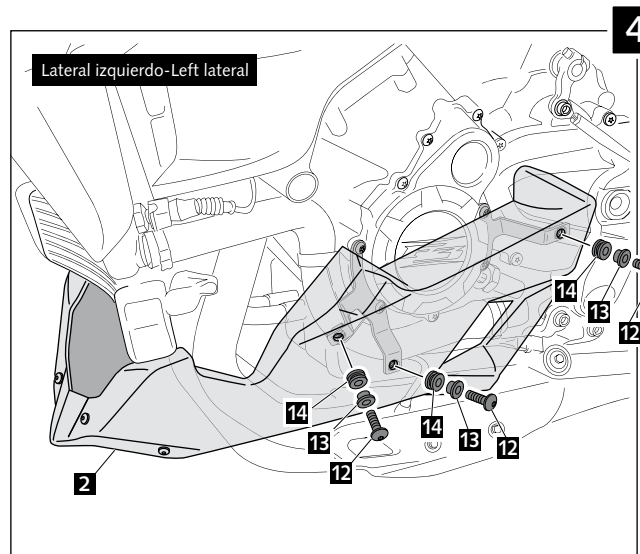
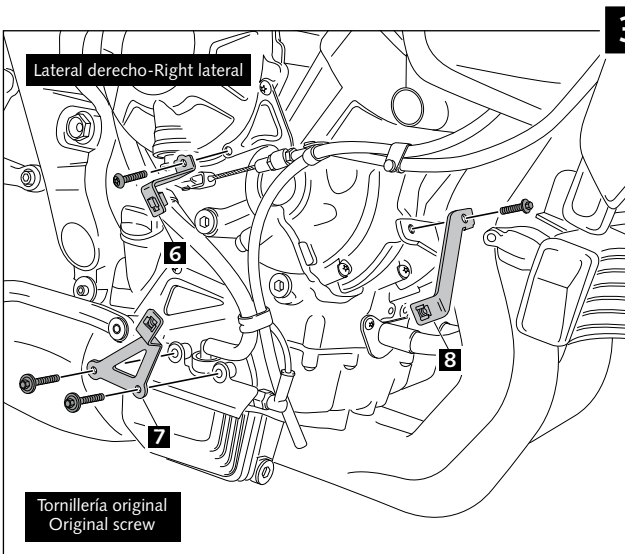
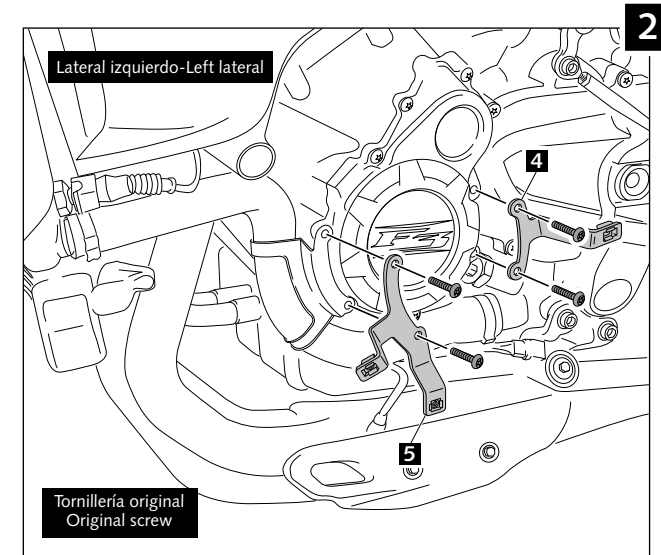
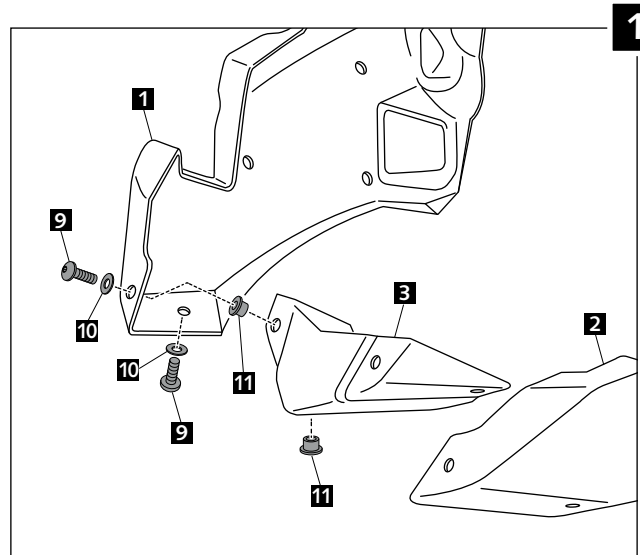
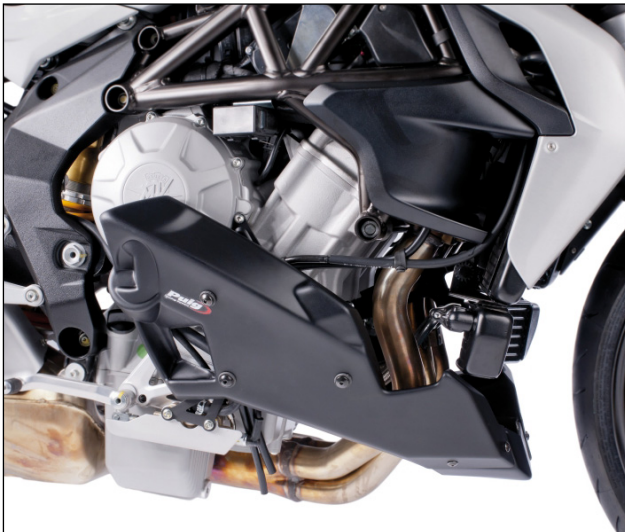

MOTOPLASTIC, S.A.















Molí de la sal, 1 - 08403 Granollers (Barcelona) SPAIN

Tel. 34 93 849 06 33 - Fax 34 93 849 09 88

info@puig.tv - info@puigusa.com

www.puig.tv - www.puigusa.com

QUILLA ADAPTABLE A – ENGINE SPOILER FOR – BUGSPOILER FÜR MV AGUSTA BRUTALE 675/800

ID.		DESCRIPCIÓN	DESCRIPTION	QTY.
1		Quilla derecha	Right engine spoiler	1
2		Quilla izquierda	Left engine spoiler	1
3		Quilla central	Central engine spoiler	1
4		Soporte metálico trasero izq. con tuerca enjaulada M6	Rear left metal support with M6 caged nut	1
5		Soporte metálico delantero izq. con tuerca enjaulada M6	Front left metal support with M6 caged nut	1
6		Sop. metálico superior derecho con tuerca M6 enjaulada	Upper right metal support with M6 caged nut	1
7		Sop. metálico inferior derecho con tuerca M6 enjaulada	Lower right metal support with M6 caged nut	1
8		Sop. metálico delantero derecho con tuerca M6 enjaulada	Front right metal support with M6 caged nut	1
9		Tornillo Allen M5x16 ISO 7380	M5x16 ISO 7380 Allen screw	4
10		Arandela de Nylon M5x0,5	M5x0,5 Nylon washer	4
11		Silemblock M5	M5 Silemblock	4
12		Tornillo Allen M6x20 ISO 7380	M6x20 ISO 7380 Allen screw	6
13		Casquillo con valona	Bush with flange	6
14		Silemblock	Silemblock	6