

BENELLI TRK251 '21 (EURO 5)

M O U N T I N G I N S T R U C T I O N S

REF 21335

PARAMANOS / HANDSGUARD



**NOT COMPATIBLE
WITH
ORIGINAL SHORT BAR ENDS**



ID	PIEZA/PART	DESCRIPCIÓN	DESCRIPTION	QTY	REF
1		Paramanos derecho	Right handguard	1	21335JM3
2		Pieza derecha anclaje manillar Ø6,5 (se suministra montada)	Ø6.5 right handlebar anchoring part (supplied mounted with handguard)	1	21335JM3
3		Paramanos izquierdo	Left handguard	1	21335JM3
4		Pieza izquierda anclaje manillar Ø6,5 (se suministra montada)	Ø6.5 left handlebar anchoring part (supplied mounted with handguard)	1	21335JM3
5		Soporte metálico derecho (R)	Right metal support (R)	1	SOPOR2P2-R21335
6		Soporte metálico izquierdo (L)	Left metal support (L)	1	SOPOR2P2-L21335
7		Tornillo Allen M6X55 DIN7991 (negro)	M6X55 DIN7991 Allen screw (black)	2	TORNI-D7991-751
8		Tornillo Allen M5x12 Ø11 ISO 7380	Allen screw M5x12 Ø11 ISO 7380	2	TORNI-AI----520
9		Casquillo Ø10 x Ø14 x25mm	Ø10 x Ø14 x25mm Arrowhead	2	CASQUI-----234
10		Arandela de nylon M5x1	M5x1 nylon washer	6	ARNV00000000245
11		Arandela de goma Ø4,5 x Ø11 x 2mm	Ø4,5 x Ø11 x 2mm Rubber washer	6	ARAND-EPDM--722
12		Arandela de plástico Ø30 x Ø6	Ø30 x Ø6 plastic washer	2	ARAND-PN6X30-67
13		Tapón tornillo M5 ISO 7380	M5 ISO 7380 Allen screw cap	6	TAPON-----85
14		Tornillo Allen M5x16 Ø11 ISO 7380	Allen screw M5x16 Ø11 ISO 7380	4	TORNI-I7380-493
15		Tuerca grafilada M5	M5 special nut	4	TUERC-D6923-255
16		Kit adhesivos	Stickers set	1	ADHESI-----234

BENELLI TRK251 '21- (EURO 5)

INSTRUCCIONES DE MONTAJE - MOUNTING INSTRUCTIONS - MONTAGEANLEITUNG

1

DISASSEMBLY
DESMONTAJE

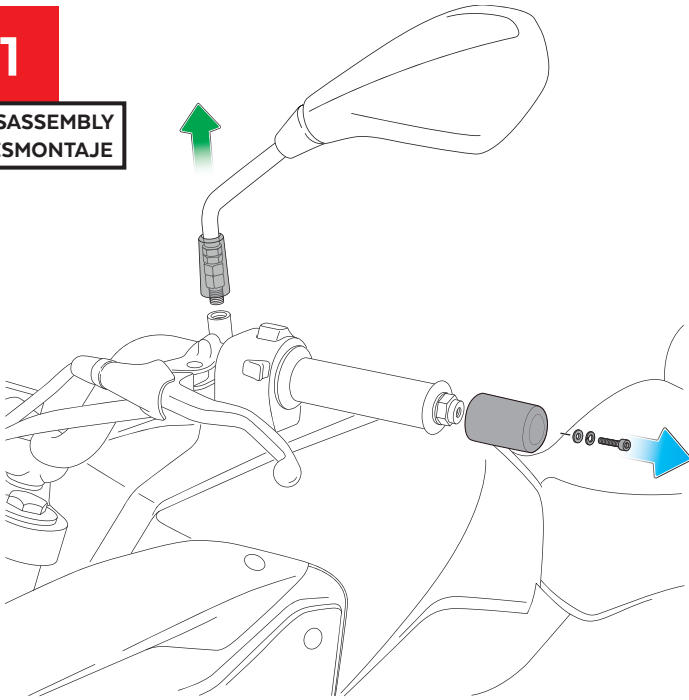

2

ASSEMBLY
MONTAJE

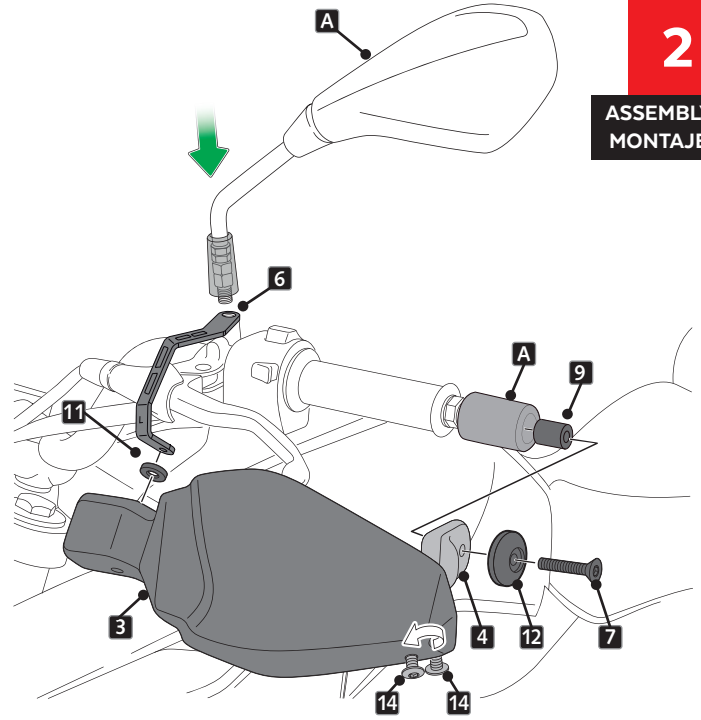

A PIEZA ORIGINAL
ORIGINAL PART

14 Aflojar 1 vuelta
Loose one turn

3

ASSEMBLY
MONTAJE

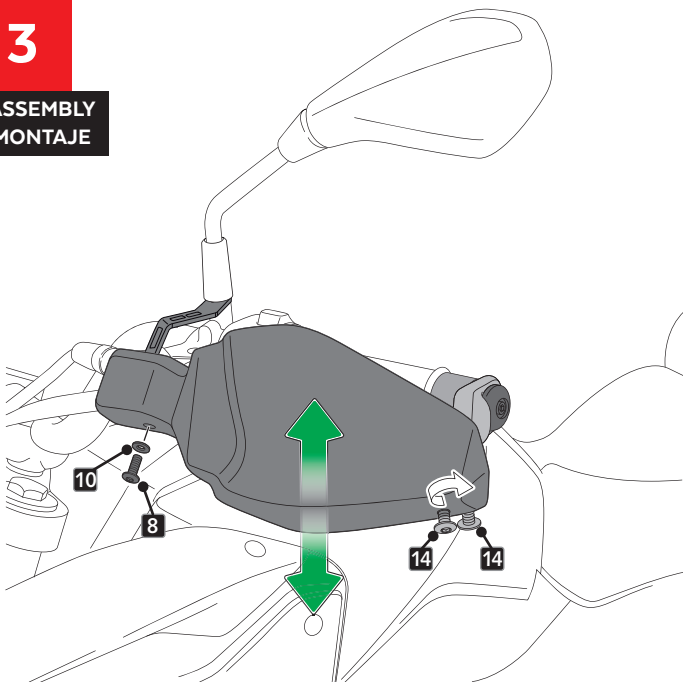

3 Ajustar posición paramanos
Adjust handguard position

14 Apretar los tornillos
Tight fasteners

4

ASSEMBLY
MONTAJE

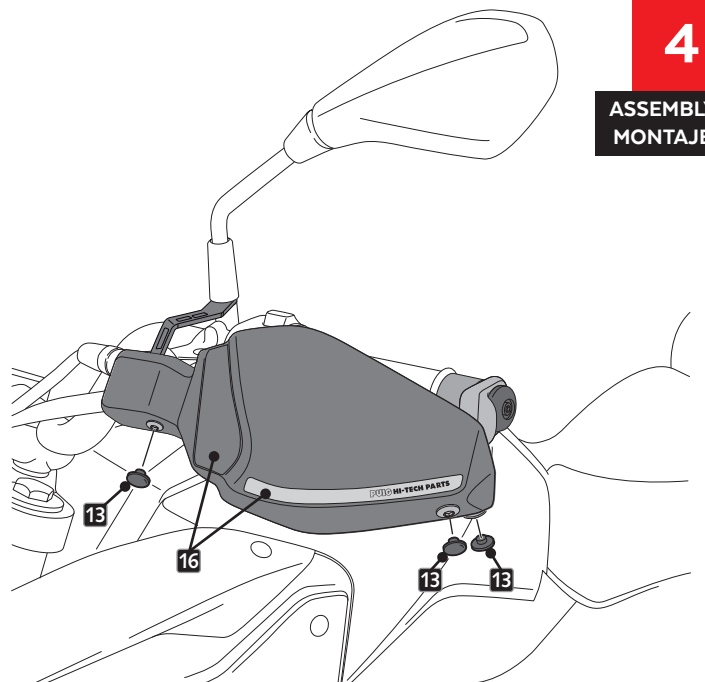

BENELLI TRK251 '21- (EURO 5)

INSTRUCCIONES DE MONTAJE - MOUNTING INSTRUCTIONS - MONTAGEANLEITUNG

5

**DISASSEMBLY
DESMONTAJE**

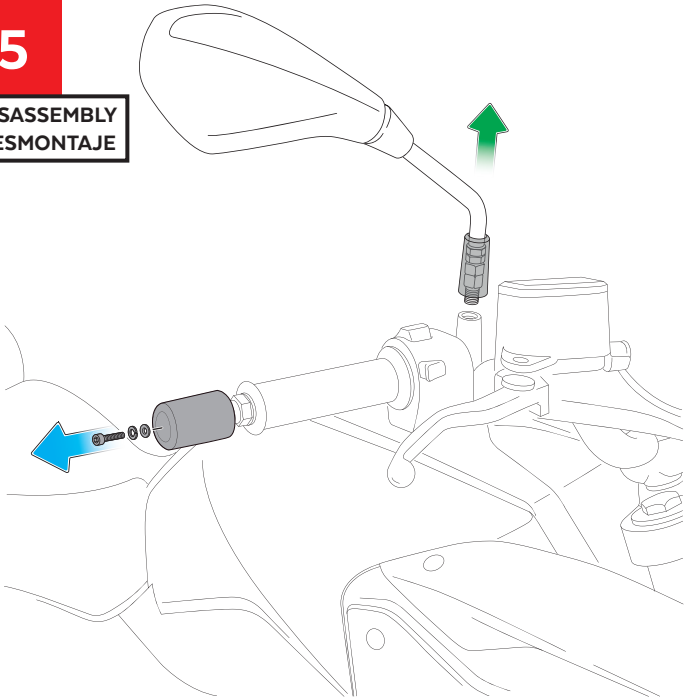

6

**ASSEMBLY
MONTAJE**

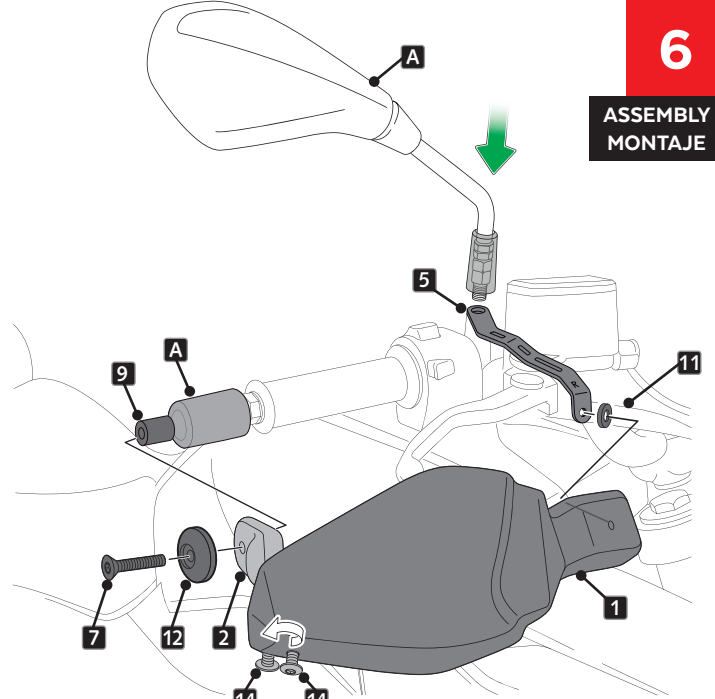

A PIEZA ORIGINAL
ORIGINAL PART

14 Aflojar 1 vuelta
Loose one turn

7

**ASSEMBLY
MONTAJE**

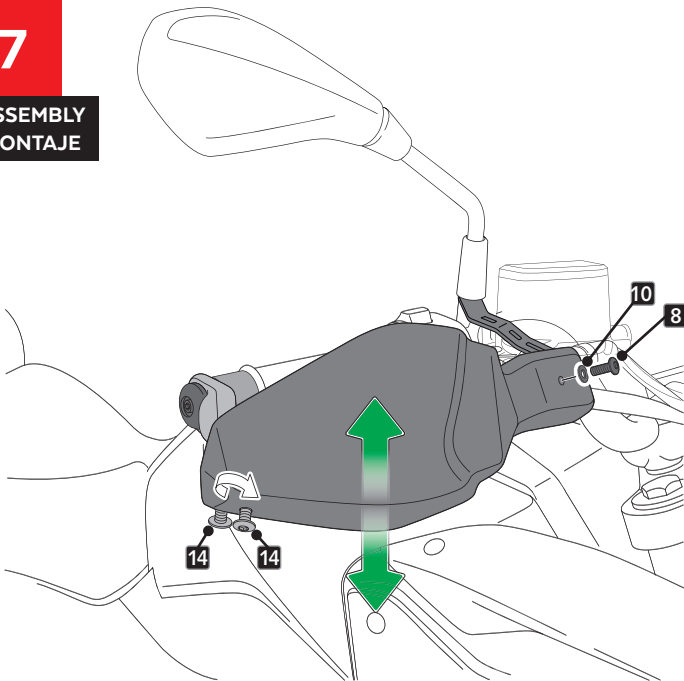

1 Ajustar posición paramanos
Adjust handguard position

14 Apretar los tornillos
Tight fasteners

8

**ASSEMBLY
MONTAJE**

