

HONDA NC750X '21-

M O U N T I N G I N S T R U C T I O N S

REF 20752

TOURING SCREEN

1 Person

15 min

EASY



ALLEN

Nº 3
Nº 5

ID.	PIEZA/PART	DESCRIPCIÓN	DESCRIPTION	QTY.	REF.:
1		Cúpula TOURING	TOURING screen	1	20752F/H/W/NM3
2		Silentblock Ø9xØ6x8 mm	Ø9xØ6x8 mm silentblock	4	AROPASACABLES-3
3		Casquillo con valona Ø12xØ6x7,3	Ø12xØ6x7,3 bush with flange	4	CASQUI-1A---750
4		Tornillo allen M5x20 Ø11 ISO 7380	M5x20 Ø11 ISO 7380 allen screw	4	TORNI-I7380-730
5		Tapon tornillo M5 ISO 7380	M5 ISO 7380 screw cap	4	TAPON-----85

HONDA NC750X '21-

INSTRUCCIONES DE MONTAJE - MOUNTING INSTRUCTIONS - MONTAGEANLEITUNG

1

DISASSEMBLY
DESMONTAJE

A Tornillería original
Original screws

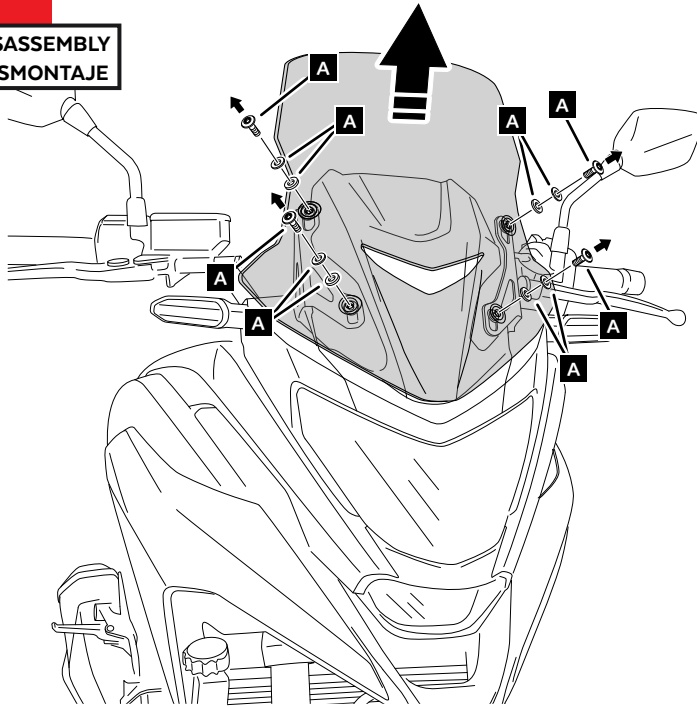

2

ASSEMBLY
MONTAJE

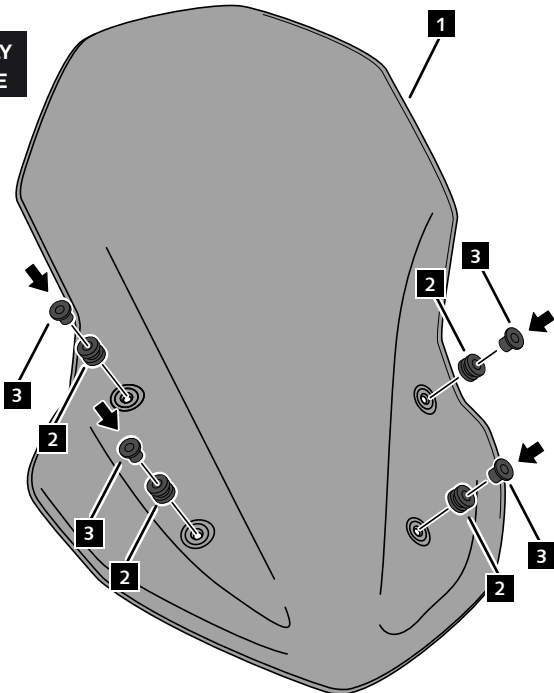

3

ASSEMBLY
MONTAJE

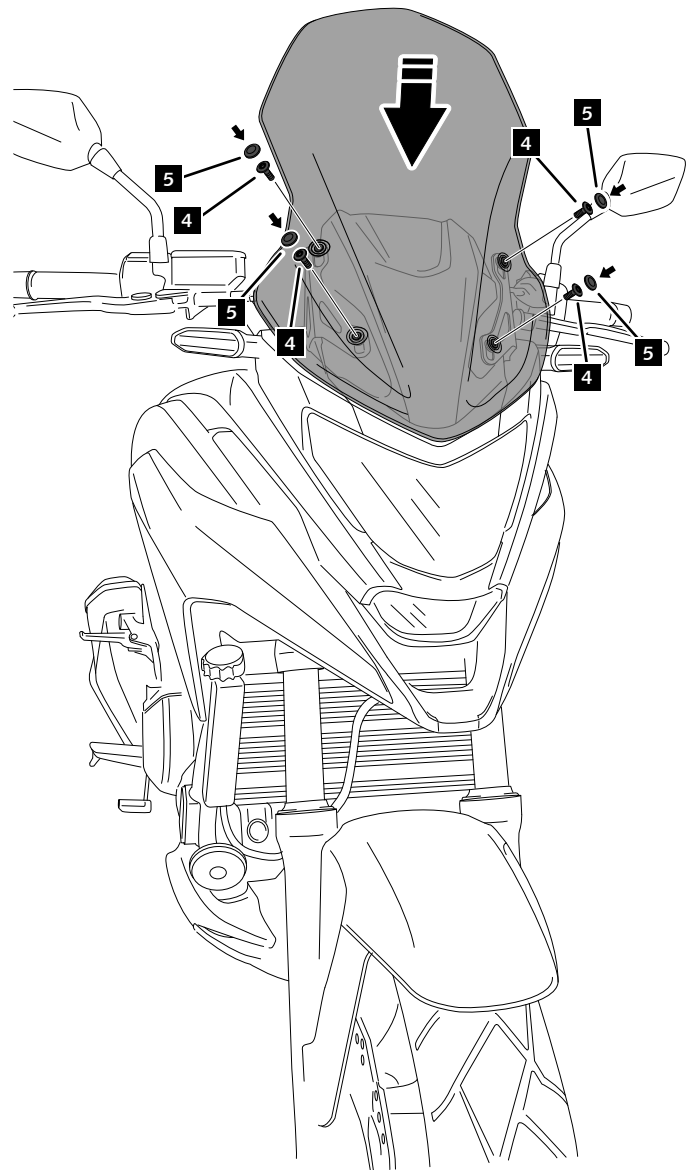

VISERA MULTIREGULABLE MULTI-ADJUSTABLE VISOR

CÚPULA TIPO
TYPE WINDSCREEN **A**



CÚPULA TIPO
TYPE WINDSCREEN **B**



CÚPULA TIPO
TYPE WINDSCREEN **C**



Ref.: 6007

Ref.: 5852

Ref.: 5853

Ahumado/Smoke

Transparente/Clear

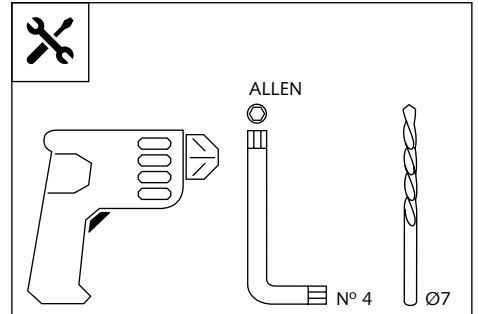

1 persona
1 person



15 min





Fácil - Easy

Media-Intermediate

Difícil-Difficult

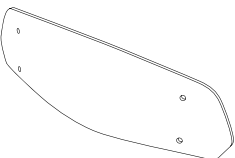
Nota/Note:

Si la visera se suministra con la cúpula Puig, no será necesario realizar los agujeros por que ya vienen incorporados.
If the visor is supplied along with the windscreen, the windscreen will come factory-drilled so no drilling is necessary.

ID.	PIEZA / PART	DESCRIPCIÓN	DESCRIPTION	QTY.
1		Visera	Visor	1
2		Plantilla	Template	1
3		Mecanismo multiregulable	Multi-adjustable mechanism	2
4		Tapeta	Cap	4
5		Tornillo rosca plástico M6x12	Plastic thread fastener M6x12	8

VISERA MULTIREGULABLE MULTI-ADJUSTABLE VISOR

INSTRUCCIONES DE MONTAJE - MOUNTING INSTRUCTIONS - MONTAGEANLEITUNG

TIPO/TIPO A - TIPO/TIPO A - TIPO/TIPO A

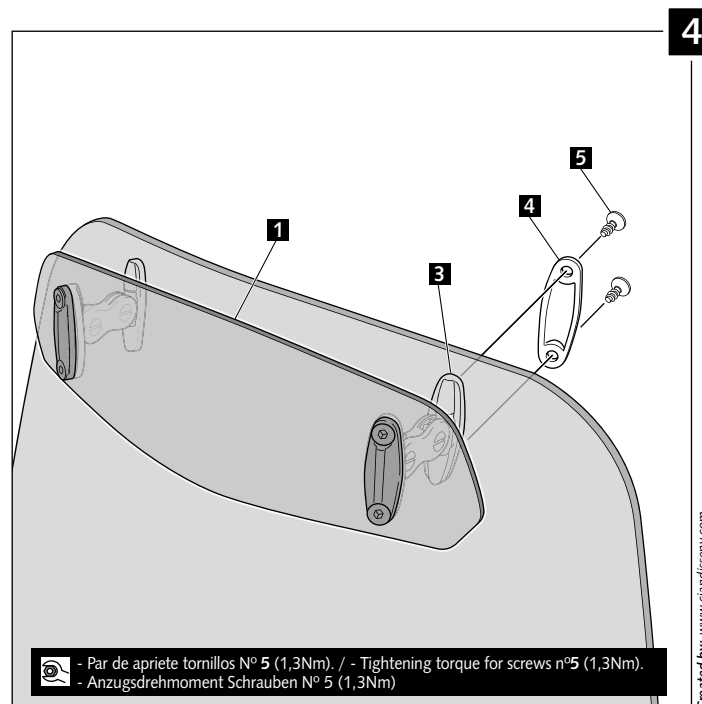
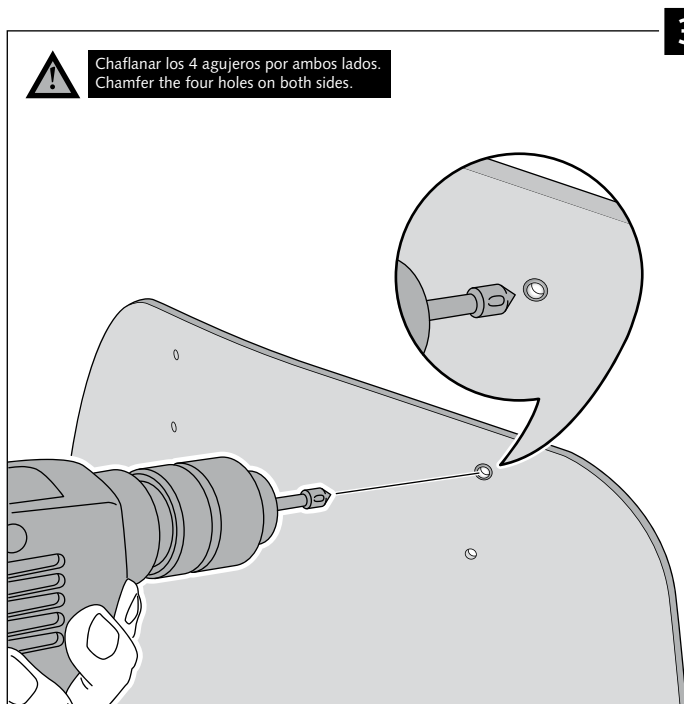
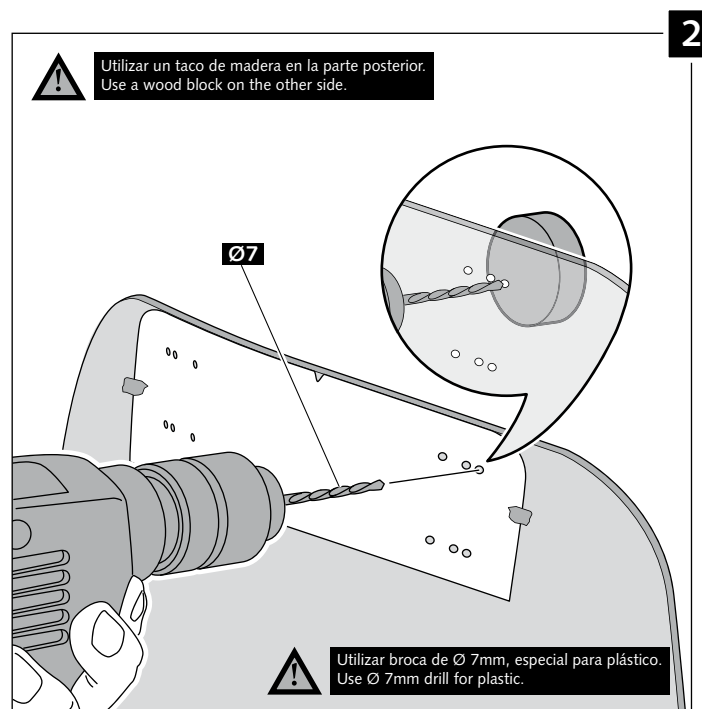
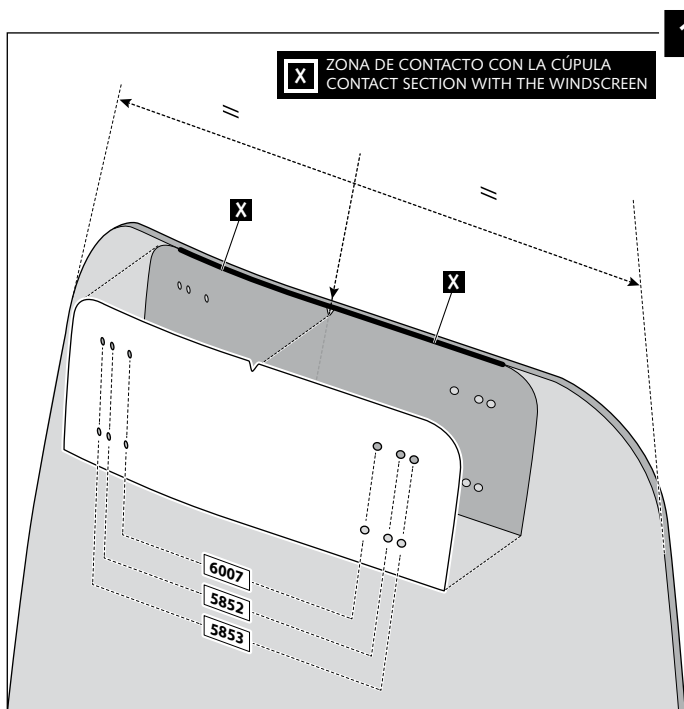

VISERA MULTIREGULABLE MULTI-ADJUSTABLE VISOR

INSTRUCCIONES DE MONTAJE - MOUNTING INSTRUCTIONS - MONTAGEANLEITUNG

TIPO/TYPE B - TIPO/TYPE B - TIPO/TYPE B

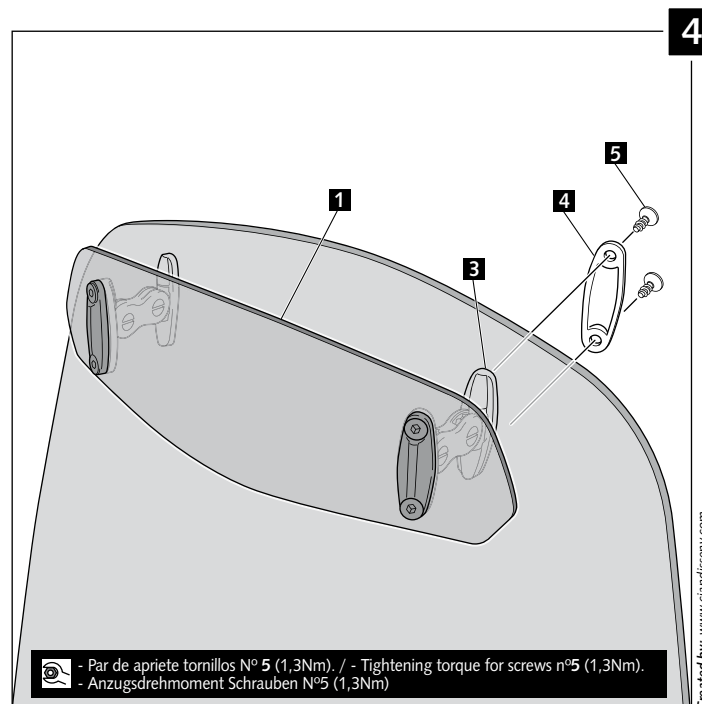
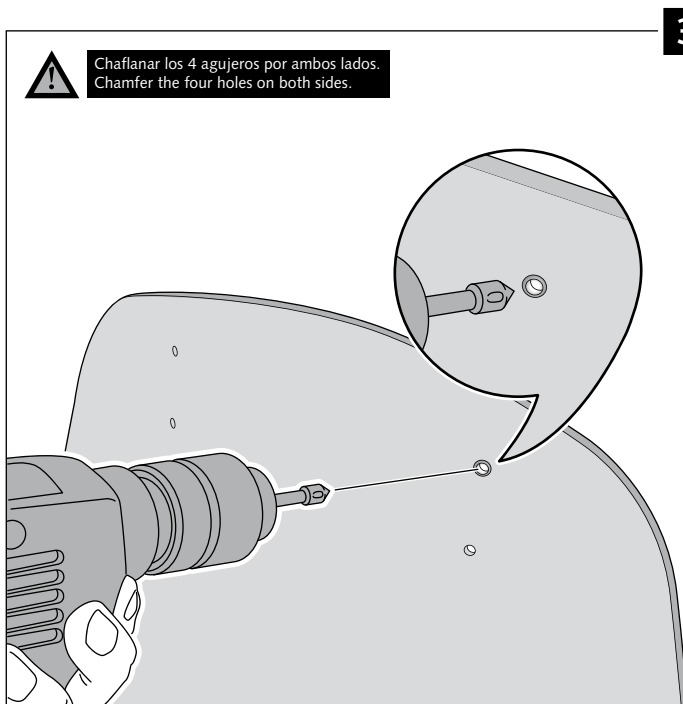
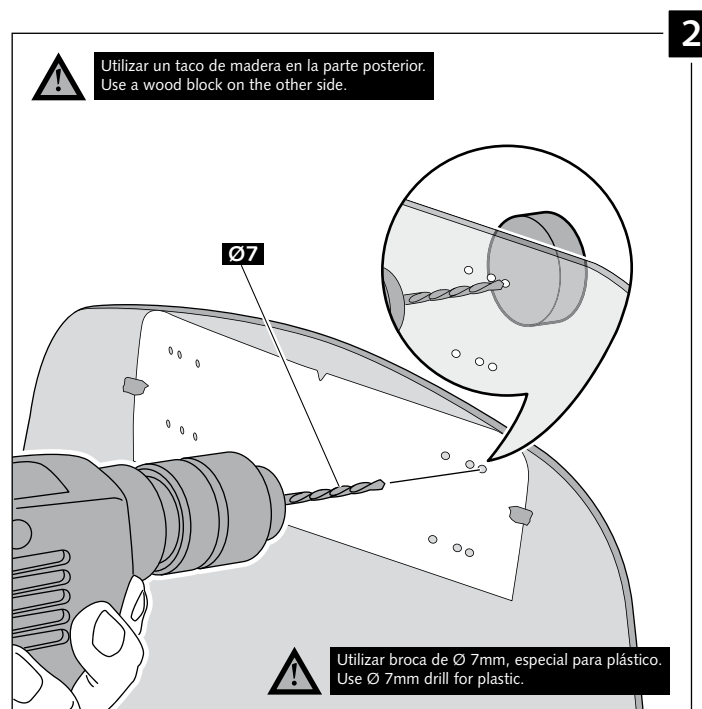
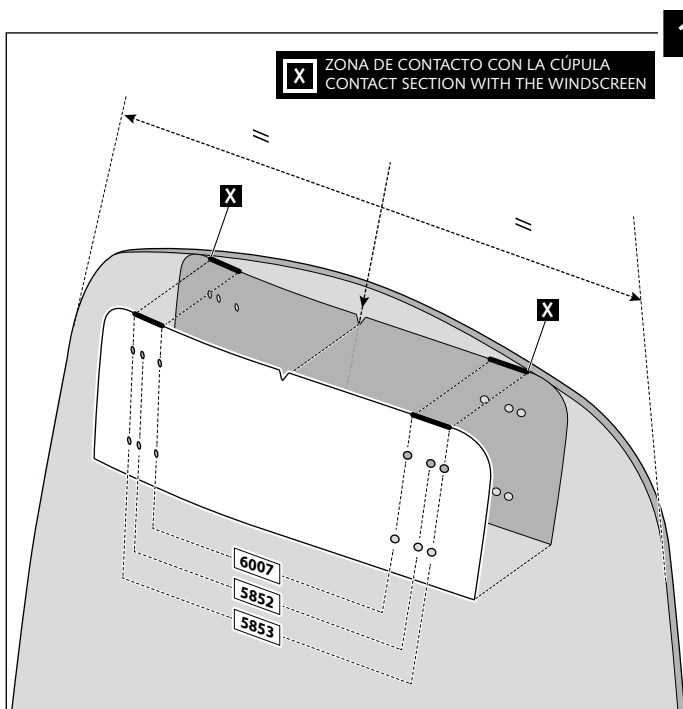

VISERA MULTIREGULABLE MULTI-ADJUSTABLE VISOR

INSTRUCCIONES DE MONTAJE - MOUNTING INSTRUCTIONS - MONTAGEANLEITUNG

TIPO/TYPER C - TIPO/TYPER C - TIPO/TYPER C

