

PANTALLA CON MECANISMO AUTO-AJUSTABLE PARA SCREEN WITH SELF-ADJUSTABLE SYSTEM FOR TRIUMPH TIGER 800 '15- '17

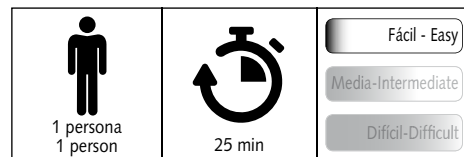

Ref.: 5652

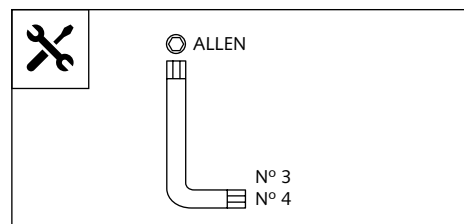

ID	PIEZA / PART	DESCRIPCIÓN	DESCRIPTION	QTY	REF.
1		Pantalla	Screen	1	5652H/F/N/WM3
2		Soporte derecho móvil	Mobile right support	1	SOPOR-4P-9-5652
3		Soporte derecho fijo	Fixed right support	1	SOPOR-4P-9-5652
4		Soporte izquierdo móvil	Mobile left support	1	SOPOR-4P-9-5652
5		Soporte izquierdo fijo	Fixed left support	1	SOPOR-4P-9-5652
6		Arandela de plástico cónica Ø20 x Ø6 x 5mm	Ø20 x Ø6 x 5mm plastic conic washer	2	ARANDENND20-030
7		Tornillo Allen M6x20 DIN7991	M6x20 DIN7991 Allen screw	2	TORNIAD7991-129
8		Pomo fijación M8	Fixation Knob M8	2	POMOFIJACION-76
9		Silentblock M6	M6 Silentblock	2	SILENBTM6-046/2
10		Arandela de nylon Ø14x Ø8 x1	Ø14x Ø8 x1 nylon washer	2	ARNV00000000265
11		Tornillo Allen M5x16 ISO 7380	M5x16 ISO 7380 Allen screw	2	TORNI-I7380-493
12		Casquillo con valona Ø15 xØ9 x7,5	Ø15 xØ9 x7,5 bush with flange	2	CASQUI-1A---324
13		Silentblock Ø20x Ø9 xØ7,5	Ø20x Ø9 xØ7,5 Silentblock	2	SILENB0000000036
14		Tuerca M5 DIN985	M5 DIN985 nut	2	TUERCA-D985-535
15		Tapón M6 DIN7991	M6 DIN7991 screw cap	2	TAPON-----81
16		Tuerca M8 DIN934	M8 DIN934 nut	2	TUERCAED934-068

PANTALLA CON MECANISMO AUTO-AJUSTABLE PARA
 SCREEN WITH SELF-ADJUSTABLE SYSTEM FOR
TRIUMPH TIGER 800 '15- '17

INSTRUCCIONES DE MONTAJE - MOUNTING INSTRUCTIONS - MONTAGEANLEITUNG

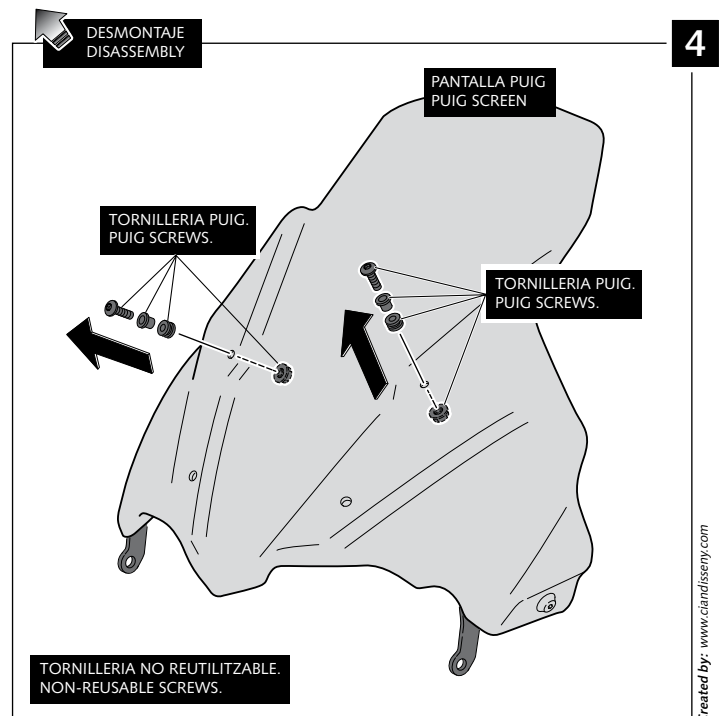
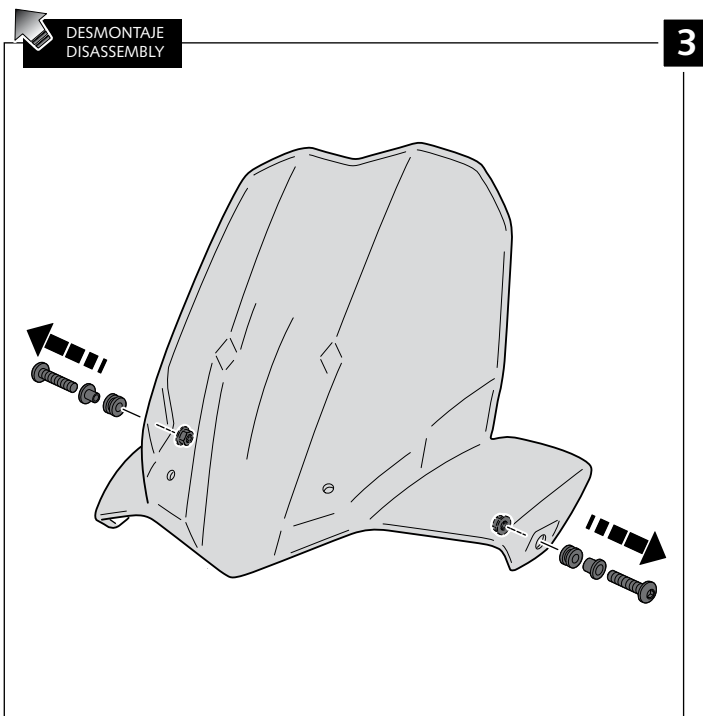
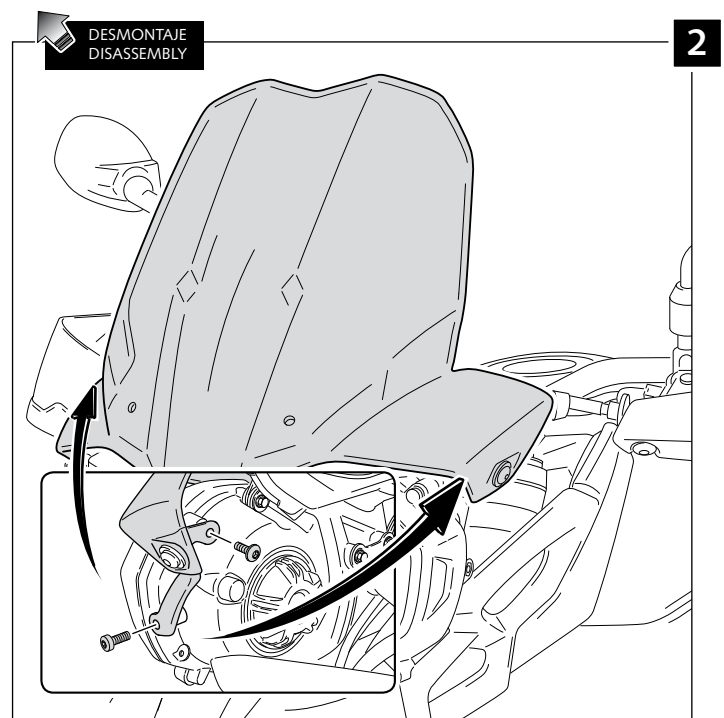
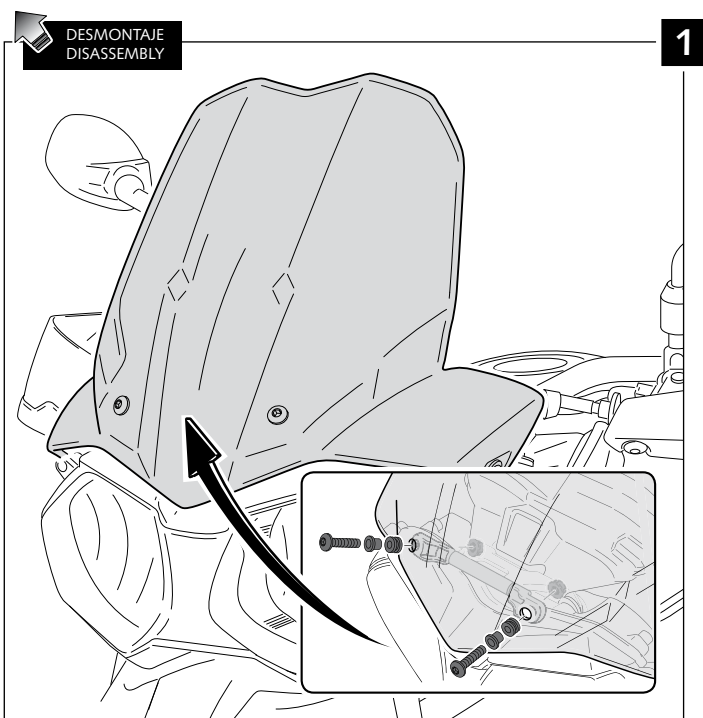

PANTALLA CON MECANISMO AUTO-AJUSTABLE PARA
 SCREEN WITH SELF-ADJUSTABLE SYSTEM FOR
TRIUMPH TIGER 800 '15- '17

INSTRUCCIONES DE MONTAJE - MOUNTING INSTRUCTIONS - MONTAGEANLEITUNG

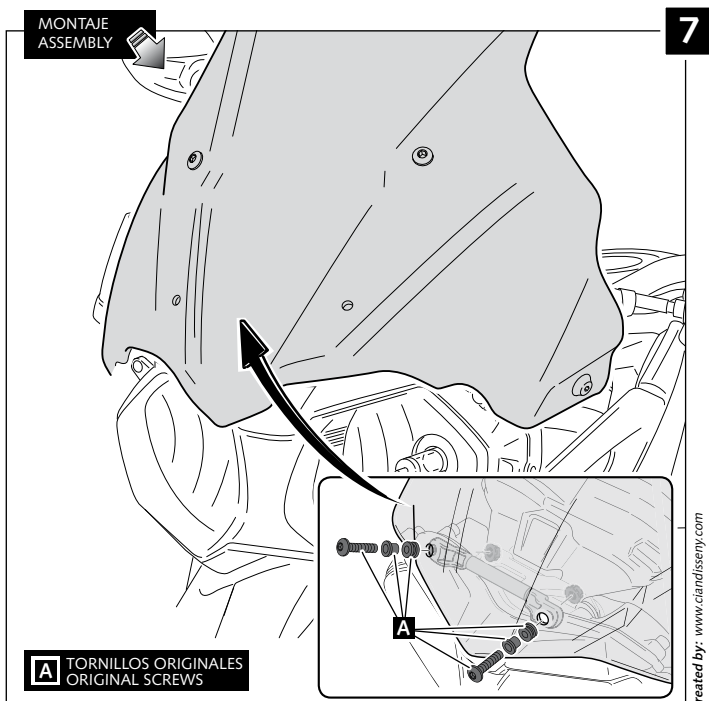
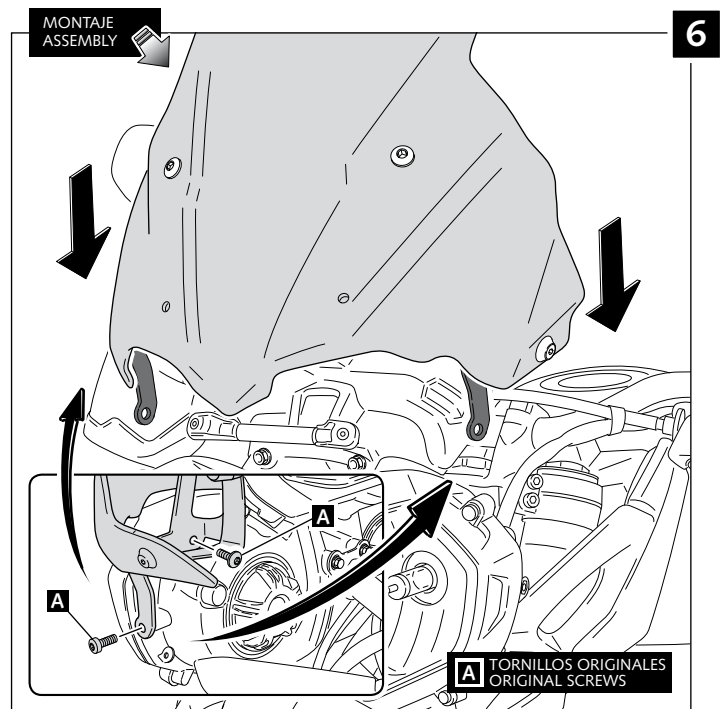
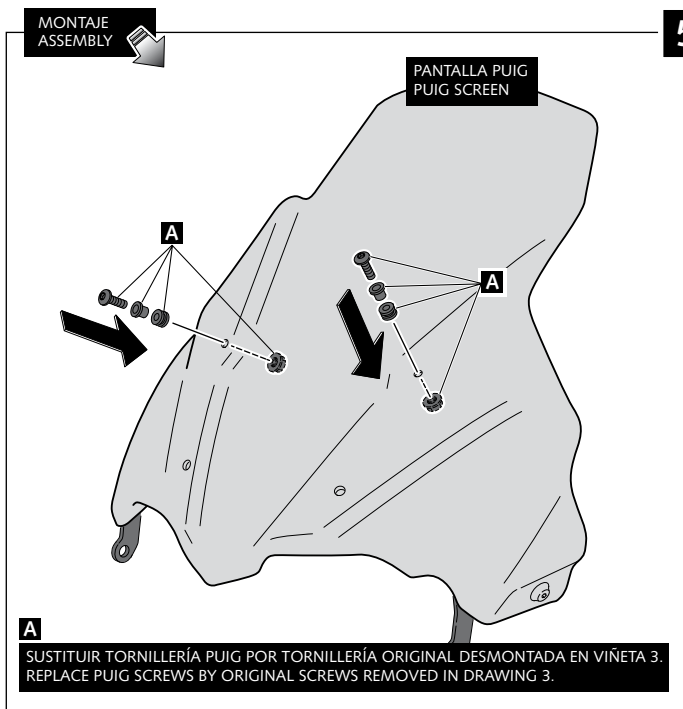

PANTALLA CON MECANISMO AUTO-AJUSTABLE PARA SCREEN WITH SELF-ADJUSTABLE SYSTEM FOR TRIUMPH TIGER 800 '15- '17

INSTRUCCIONES DE MONTAJE - MOUNTING INSTRUCTIONS - MONTAGEANLEITUNG

DESPIECE
EXPLOTING

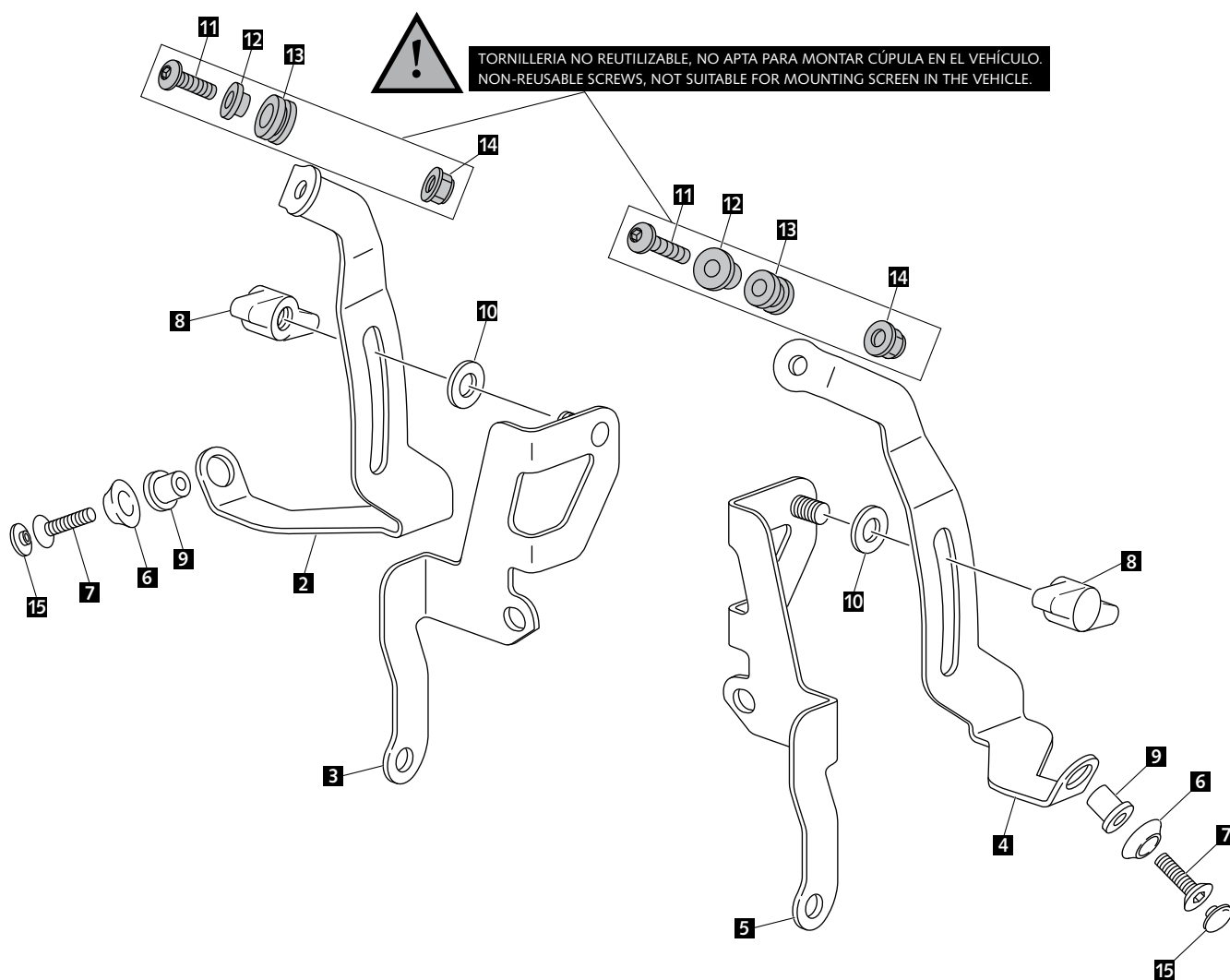

VISERA MULTIREGULABLE MULTI-ADJUSTABLE VISOR

CÚPULA TIPO
TYPE WINDSCREEN **A**



CÚPULA TIPO
TYPE WINDSCREEN **B**



CÚPULA TIPO
TYPE WINDSCREEN **C**



Ref.: 6007

Ref.: 5852

Ref.: 5853

Ahumado/Smoke

Transparente/Clear

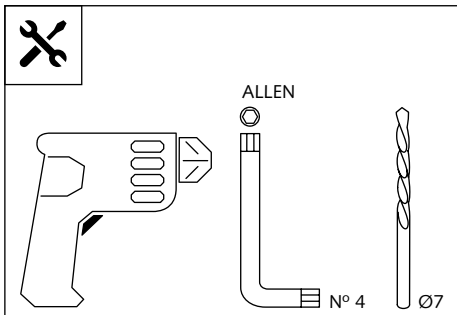

1 persona
1 person



15 min

Fácil - Easy

Media-Intermediate

Difícil-Difficult

Nota/Note:

Si la visera se suministra con la cúpula Puig, no será necesario realizar los agujeros por que ya vienen incorporados.

If the visor is supplied along with the windscreen, the windscreen will come factory-drilled so no drilling is necessary.

ID.	PIEZA / PART	DESCRIPCIÓN	DESCRIPTION	QTY.
1		Visera	Visor	1
2		Plantilla	Template	1
3		Mecanismo multiregulable	Multi-adjustable mechanism	2
4		Tapeta	Cap	4
5		Tornillo rosca plástico M6x12	Plastic thread fastener M6x12	8

VISERA MULTIREGULABLE MULTI-ADJUSTABLE VISOR

INSTRUCCIONES DE MONTAJE - MOUNTING INSTRUCTIONS - MONTAGEANLEITUNG

TIPO/TYPER A - TIPO/TYPER A - TIPO/TYPER A

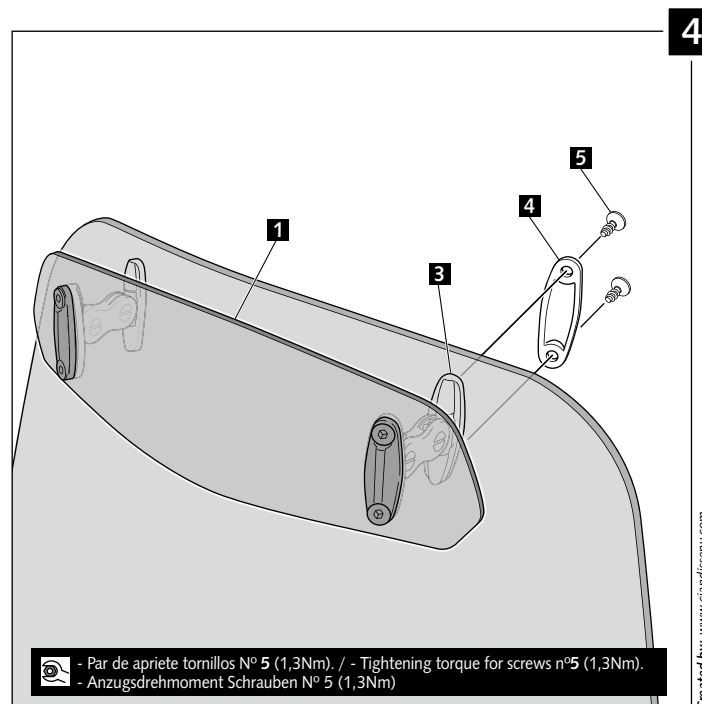
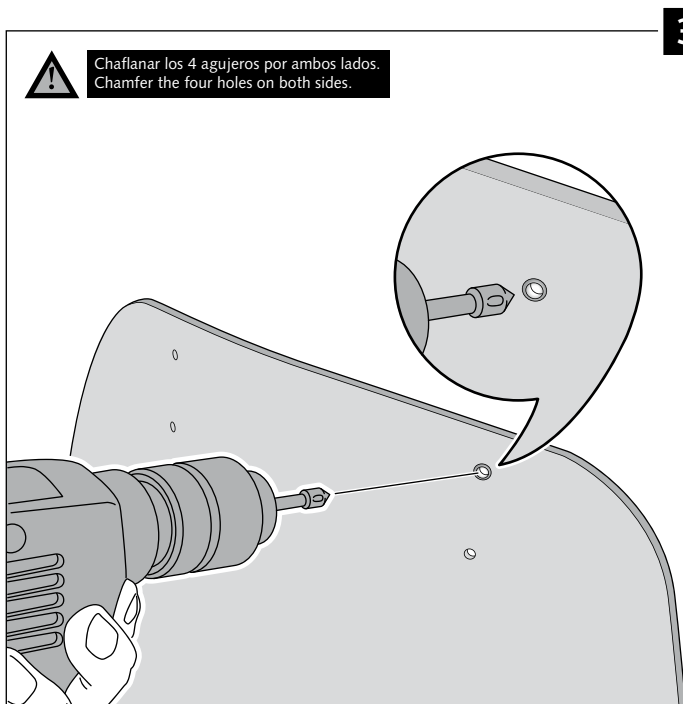
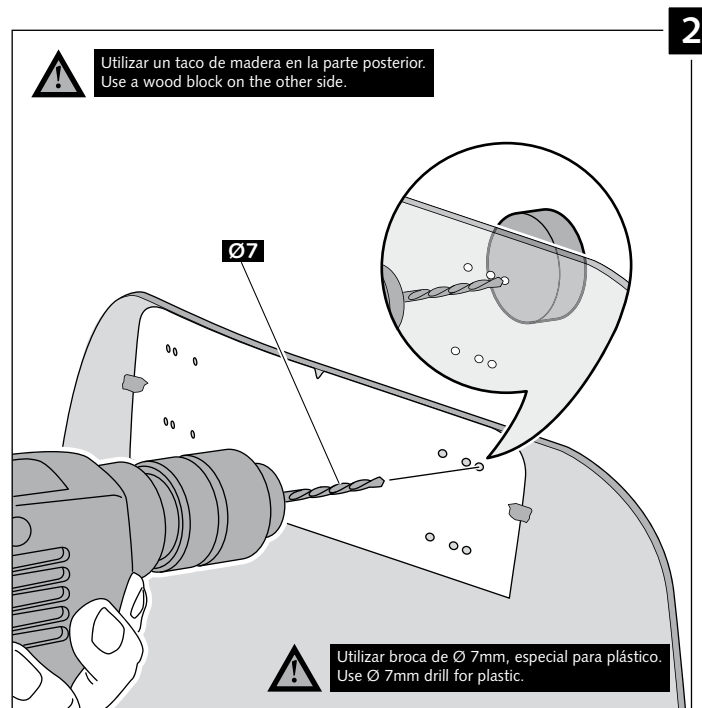
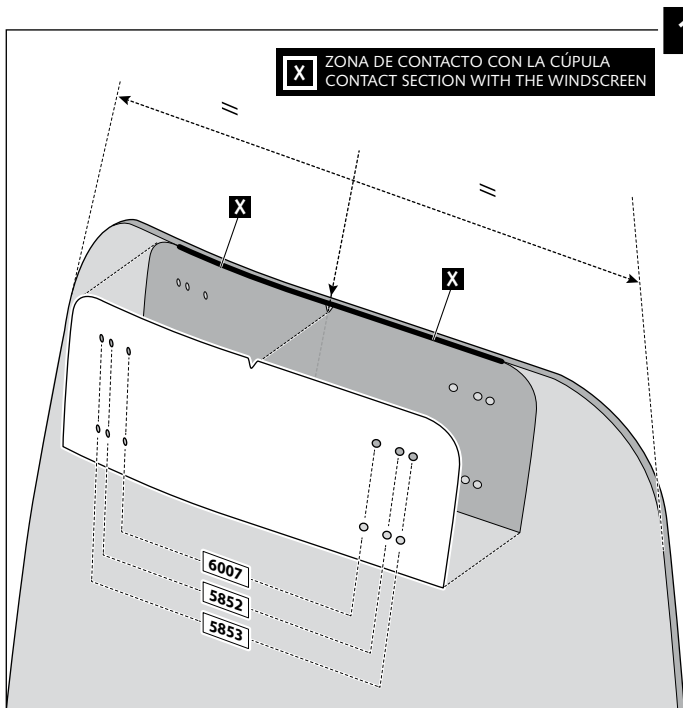

VISERA MULTIREGULABLE MULTI-ADJUSTABLE VISOR

INSTRUCCIONES DE MONTAJE - MOUNTING INSTRUCTIONS - MONTAGEANLEITUNG

TIPO/TYPE B - TIPO/TYPE B - TIPO/TYPE B

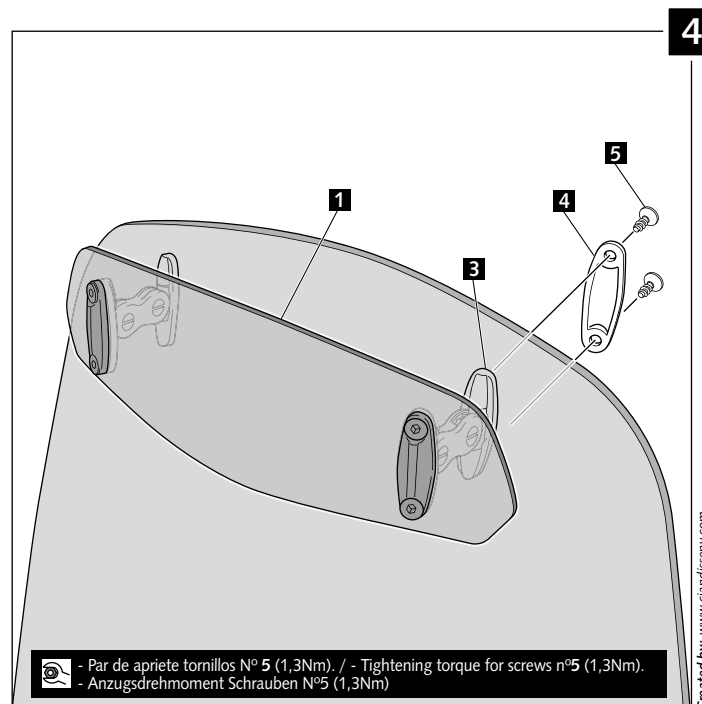
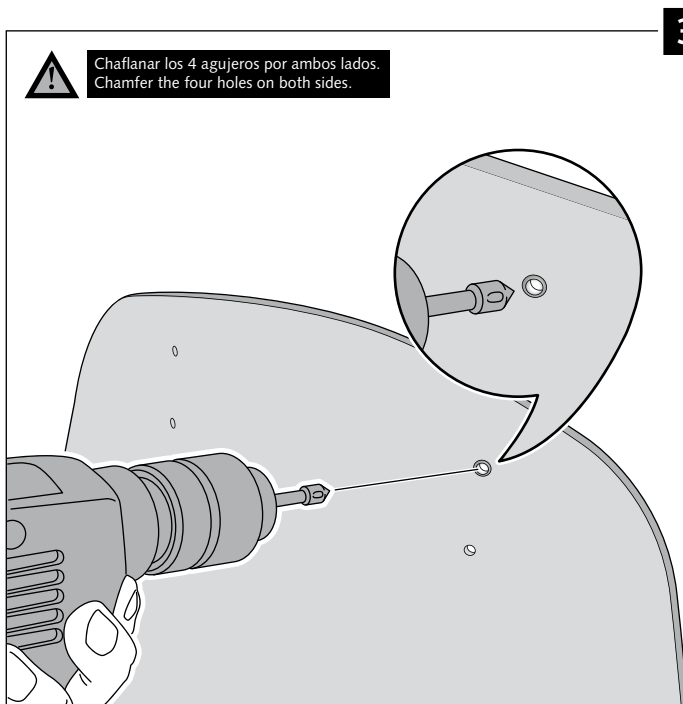
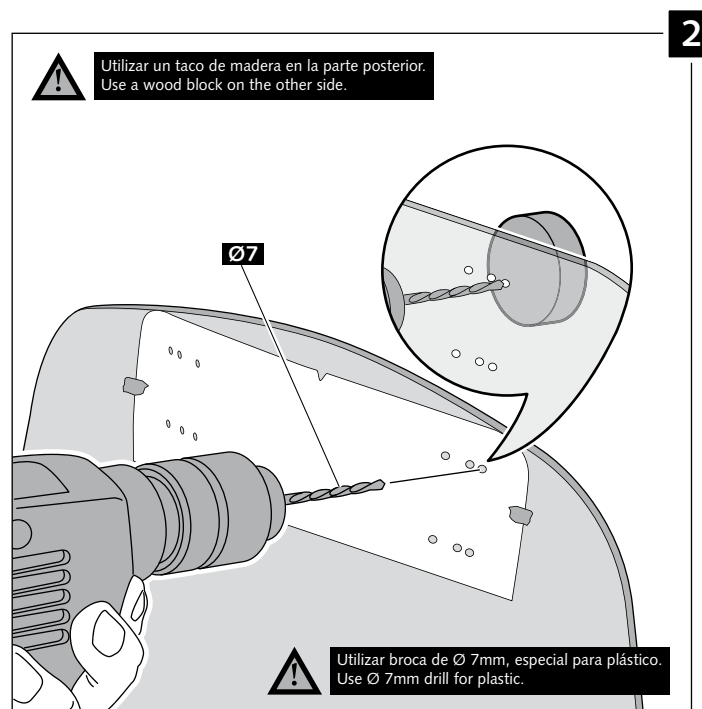
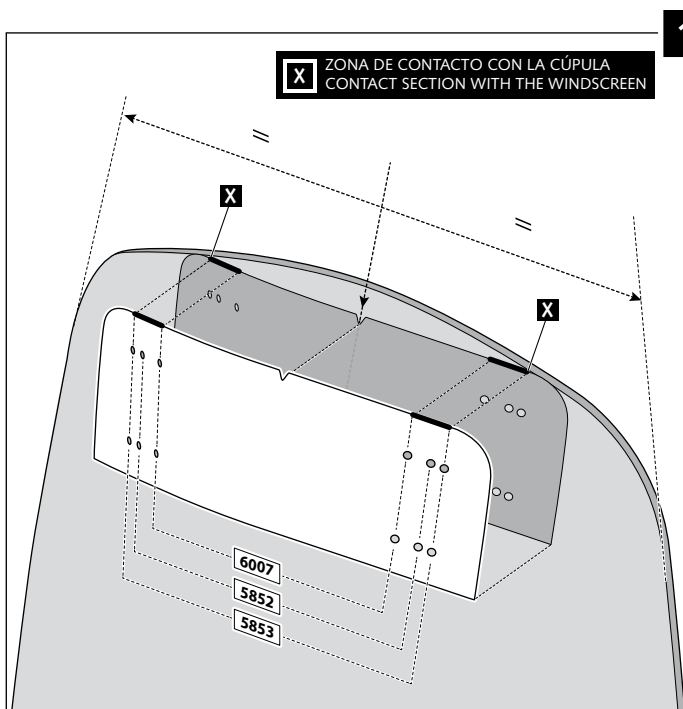

VISERA MULTIREGULABLE MULTI-ADJUSTABLE VISOR

INSTRUCCIONES DE MONTAJE - MOUNTING INSTRUCTIONS - MONTAGEANLEITUNG

TIPO/TYPER C - TIPO/TYPER C - TIPO/TYPER C

