

CONTRAPESO THRUSTER BAR ENDS THRUSTER

REF 20612N

M O U N T I N G I N S T R U C T I O N S



1 Person



15 min



EASY

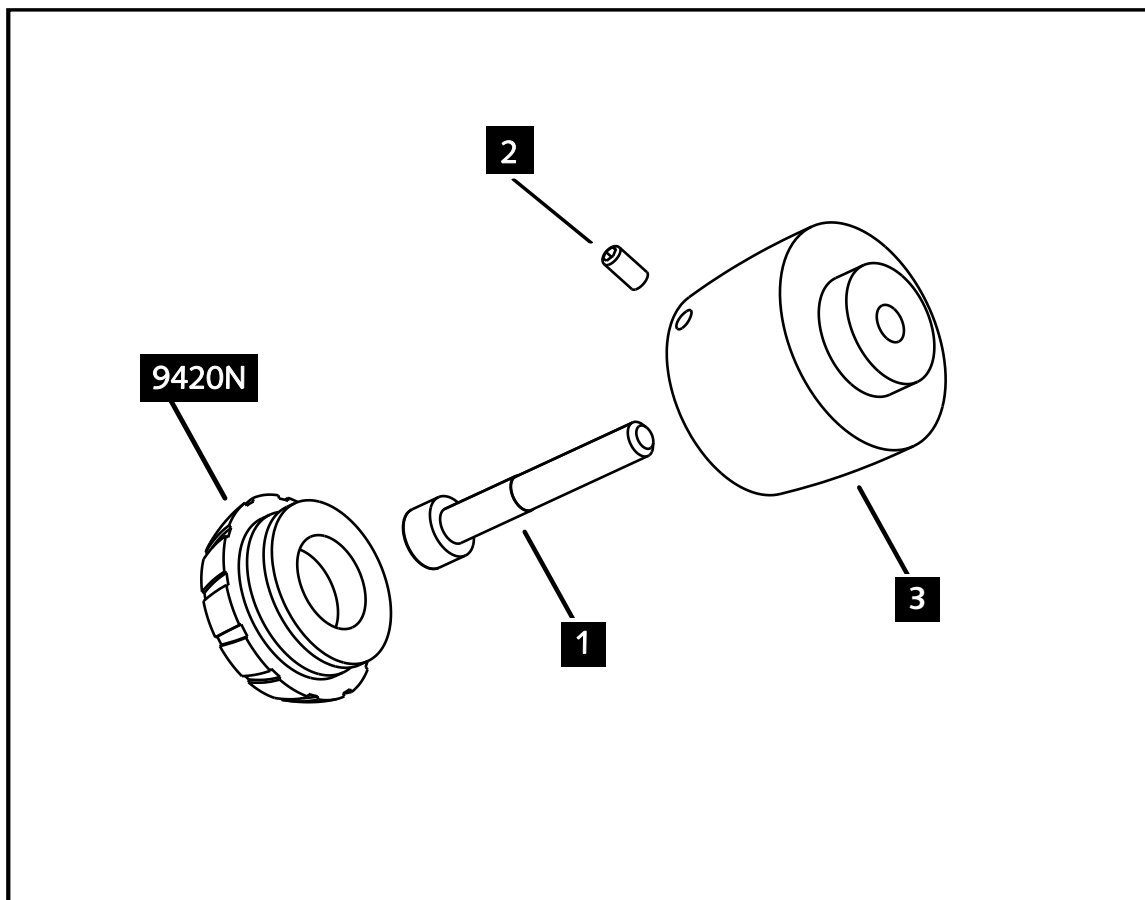

ID.	DESCRIPCIÓN	DESCRIPTION	QTY.
1	Tornillo M5x35 DIN912	M5x35 DIN912 screw	2
2	Contrapeso	Bar end	2
3	Tornillo M3x6	M3x6 screw	2

**CONSULTAR EN NUESTRA PAGINA WEB LA DISPONIBILIDAD DEL VIDEO DE MONTAJE DE ESTA REFERENCIA.
CONSULT OUR WEBSITE THE VIDEO MOUNT AVAILABILITY OF THIS REFERENCE.**